



**USER  
MANUAL**

**L15**  
SMART LOCK

---

[www.smartleelen.com](http://www.smartleelen.com)

## Menu

### 1 Important Information

- 1.1 Security
- 1.2 Warning
- 1.3 Disposal Of Old Products And Batteries

### 2 Install The Lock

- 2.1 Product List
- 2.2 Installation Three-dimensional Assembly Drawing
- 2.3 Instructions Before Installation
- 2.4 Bolt Direction Reversing
- 2.5 Installation Video

### 3 Lock Appearance

- 3.1 Appearance

### 4 Set Up The Lock

- 4.1 Enter The Management Mode
- 4.2 Add Unlocking Methods
- 4.3 Delete Unlocking Methods
- 4.4 Management Settings
- 4.5 System Settings
- 4.6 Other Settings

### 5 Use The Lock

- 5.1 Outdoor Locking/Unlocking
- 5.2 Indoor Locking/Unlocking

### 6 Other Functions

- 6.1 Restore Factory Settings
- 6.2 Battery Replacement
- 6.3 Emergency Power Supply Method
- 6.4 System Restart

### 7 Basic Parameters

### 8 Restricted Substances

## 1 Important Information

### 1.1 Security

- Before using this smart lock, please read and understand all instructions. Damage caused by failure to follow the instructions is not covered by the warranty
- Suggest using accessories specified by our company
- Only use the lithium battery configured for this product
- Do not disassemble the product forcibly, so as not to sound an alarm or damage the product
- Do not scratch the fingerprint sensor with sharp objects, or it may cause permanent damage
- Do not expose the product to corrosive substances, so as not to damage the protective layer of the shell
- Do not hang objects on the handle, so as not to affect the normal use of the door lock
- To clean the product, please wipe it with a soft cloth
- Do not remove the battery while the device is in operation
- Please choose a professional engineer to install the door lock, and follow the company's installation standards, and do not disassemble or assemble by yourself
- After the door lock is installed and debugged, please modify the default management password set at the factory as soon as possible and keep the mechanical key properly, and do not disclose the password information easily
- After the door lock triggers the low battery alarm, please replace all batteries in time and make sure the installation is correct

### 1.2 Warning

- Do not put the battery near the fire, so as not to explode
  - Do not use an emergency power source that does not comply with safety regulations to power this product
  - Do not short-circuit the pole connections of the battery leads with metal as this may cause an explosion
  - Make sure to replace by LEELEN, LEELEN authorized service centers or professionals
  - Using accessories or components produced by other manufacturers or not specifically recommended by LEELEN may invalidate your warranty
- 

### 1.3 Disposal Of Old Products And Batteries

- Please understand the local electronic product classification collection system by yourself
- Please follow local regulations and do not dispose of old batteries in normal household waste
- Proper disposal of old products helps avoid potential negative impacts on the environment and human health
- Batteries cannot be disposed of with normal household waste

## 2 Install The Lock

### 2.1 Product List

This product list is for reference only, and everything is subject to the actual packaging content.

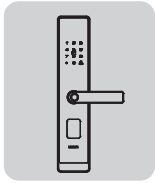

Front Panel  
(with silicone pad)  
x1

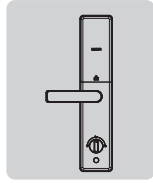

Rear Panel  
(with silicone pad)  
x1

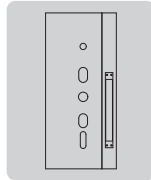

Opening Template  
x1

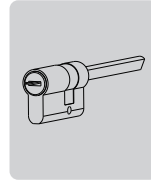

Automatic  
lock core  
x1

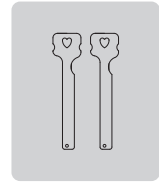

Mechanical  
Key  
x2



IC Card  
x2



Installation Kit  
x1



User's Guide  
x1

### 2.2 Installation Three-dimensional Assembly Drawing

Knowing the three-dimensional assembly diagram of the installation is conducive to understanding the structure of the lock.

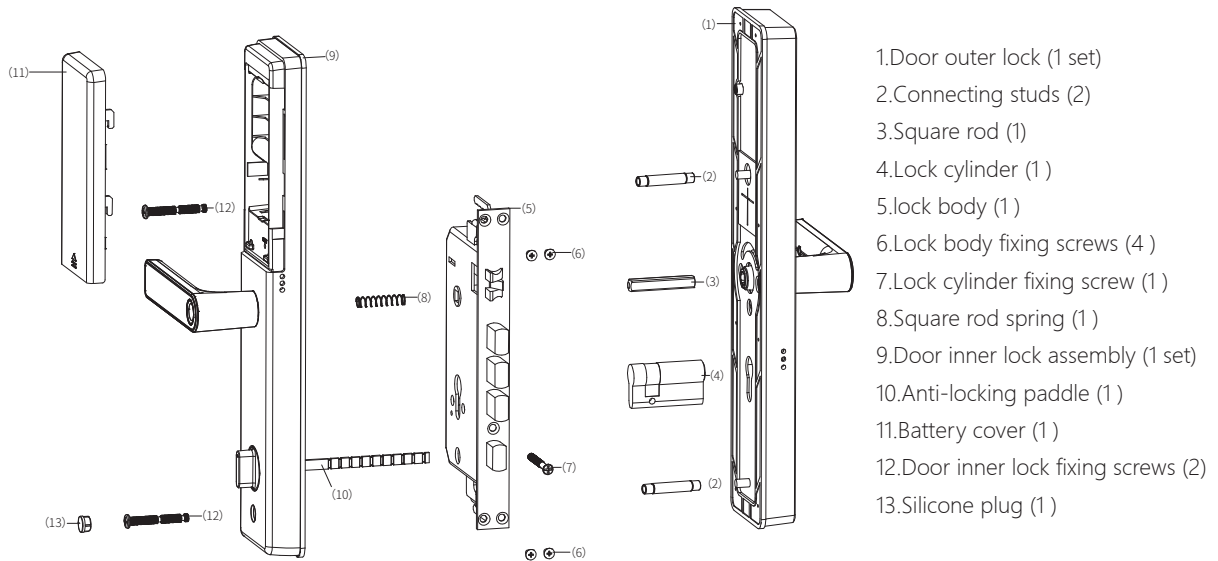

## 2.3 Instructions Before Installation

### 2.3.1 Confirm the door opening direction before installation

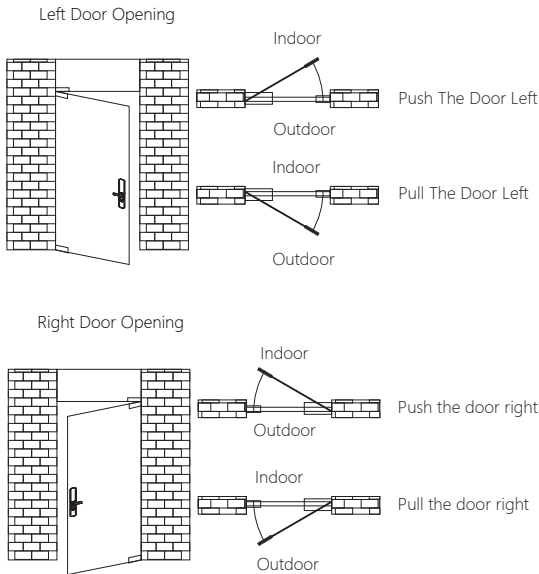

### 2.3.2 Corresponding lock body and bolt direction

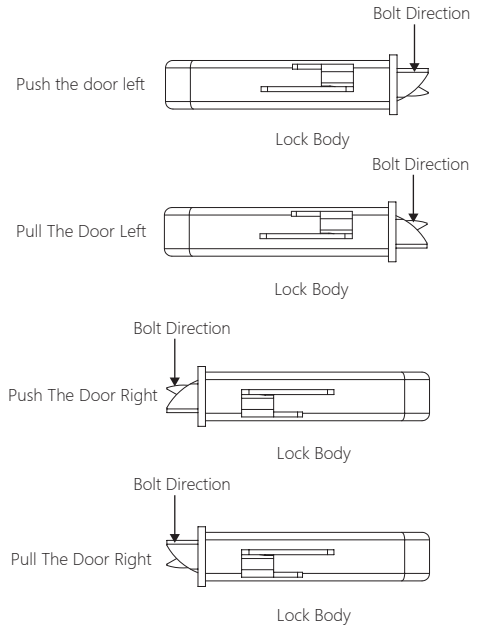

## 2.4 Bolt Direction Reversing

The lock body does not distinguish between push in and pull out. If you need to change the direction (that is, push in to pull out, or pull out to push in), please adjust the direction of the bolt before installation. The specific method is as follows:

- ① The main bolt remains locked
- ② Slightly lift outward, the bolt will automatically pop out of the side panel
- ③ Rotate the latch 180°
- ④ Press the bolt into the side panel after swiveling into position

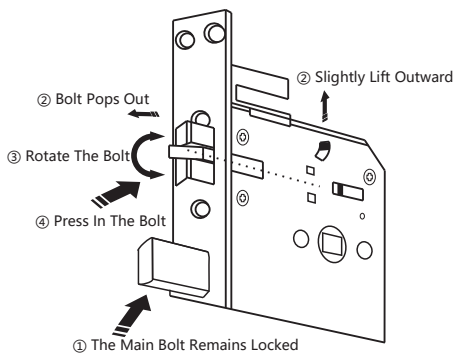

## 2.5 Installation Video

During the door lock installation process, it is necessary to try dangerous professional tools, so please be sure to hire a professional to install it. Before installation, please scan the QR code on the right, watch and follow the installation video to complete the installation.



## 3 Lock Appearance

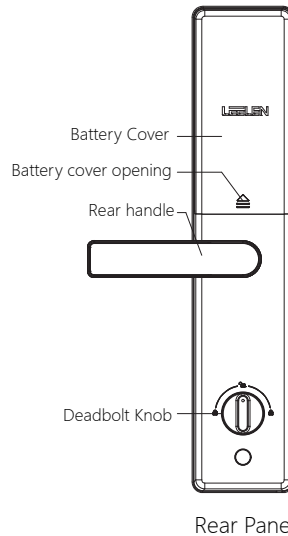
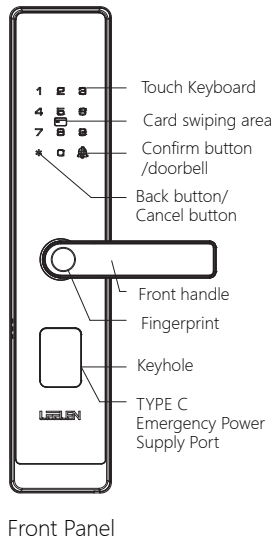

## 4 Set Up The Lock

### 4.1 Enter The Management Mode



1. Touch the touch area of the keyboard, the keyboard light will light up, and the keyboard will be awakened;
2. Press and hold the "\*" key for 2 seconds to enter the background management
3. Enter the 6-digit management password according to the voice prompt, and press "\*" to enter the management menu.

Note: After restoring the factory settings, press and hold the "\*" key for 2 seconds and enter the default management password (951058) to enter the settings menu.

### 4.2 Add Unlocking Methods

In Management Mode:

When adding a user, the door lock will automatically encode the user key, and the user only needs to enter the fingerprint, password or card according to the prompts.

#### Add user fingerprint/password/card

Press **1** to add a user, Press the **1** key to add fingerprints, and follow the voice prompts to change different angles to enter fingerprints until it prompts: the operation is successful.

Press **1** to add a user, Press the **1** key to enter to add a password. After entering the 6-digit password, enter the password again according to it prompts until the prompt: the operation is successful.

Press **1** to add a user, Press the **1** key to enter the card adding put the card in the card recognition area, until it prompts: the operation is successful.

### 4.3 Delete Unlocking Methods

In Management Mode:

Press the **2** key to delete the unlocking method, enter the user number according to the voice prompt, press # to confirm, until it prompts: the operation is successful.

### 4.4 Management Settings

#### 4.4.1 Change The Management Password

In Management Mode:

Press the **3** key to enter the management settings, and then press the **1** key to modify the management password. After entering a new 6-digit management password, follow the voice prompts and enter the management password again until it prompts: the operation is successful.

### 4.4.2 Add the management Fingerprint

In Management Mode:

Press the **3** key to enter the management settings, and then press the **2** key to add the management fingerprints, according to the voice prompts, change the angles of your fingerprint until it prompts: the operation is successful.

### 4.4.3 Delete management Fingerprint

In Management Mode:

Press the **3** key to enter the management settings, and then press the **3** key to delete the management fingerprint. According to the prompts, press the # key to confirm until it prompts: the operation is successful.

## 4.5 System Settings

### 4.5.1 Volume Settings

In Management Mode:

Press the **4** key to enter the system settings, and then press the **1** key to set the volume. According to the voice prompt, press **1** to set the high volume, press **2** to set the medium volume, press **3** to set the low volume, and press **4** to set the mute. It prompts: the operation is successful.

Note: No matter which volume mode is set, the menu indicator sound, alarm sound, and factory reset prompt sound will always maintain a medium volume.

### 4.5.2 Illegal Input Times Settings

In Management Mode:

Press the **4** key to enter the system settings, and then press the **2** key to enter the number of illegal unlocking settings. According to the prompt, enter the unlocking times of 5-9, press # to confirm, until it prompts: the operation is successful.

Note: After the setting is completed, if the user fails to unlock for more than the above times, an alarm will be triggered.

### 4.5.3 Card Encryption Settings

In Management Mode:

Press the **4** key to enter the system settings, then press the **3** key to enter the card encryption setting, press the **1** key to enable it, press the **2** key to disable it, until it prompts: the operation is successful. Encryption is enabled by default.

In Admin Mode:

▲ After opening, the use and entry of the card can be more secure and cannot be copied. If disabled, the security level of the card is reduced, but the applicability is enhanced, such as the door lock can be opened by copying the card through the mobile phone.

### 4.5.4 Double Verification Settings

In Management Mode:

Press the **4** key to enter the system settings, then press the **4** key to enter the double verification settings setting, and press the **1** key to enable it, press the **2** key to disable it, until it prompts: the operation is successful. Double verification is disabled by default.

### 4.5.5 Normally open Settings

In Management Mode:

Press the **4** key to enter the system settings, then press the **5** key to enter the normally open setting, press the **1** key to enable it, press the **2** key to disable it, until it prompts: the operation is successful.

### 4.5.6 One-time password Settings

In Management Mode:

Press the **4** key to enter the system settings, then press the **6** key to enter the one-time password setting, Enter a 6-digit password as a one-time password, until it prompts: the operation is successful. remote unlock is enabled by default.

### 4.5.7 Screen off card swiping Settings

In Management Mode:

Press the **4** key to enter the system settings, then press the **7** key to enter the Screen off card swiping setting, and press the **1** key to enable it, press the **2** key to disable it, until it prompts: the operation is successful. Screen off card swiping is disabled by default.

## 4.6 Other Settings

### 4.6.1 Unlocking direction Settings

 **8 8 8 #**

If the door lock only has the default management password, press 888#, and the voice prompt "Press **1** to open the door on the right, press **2** to open the door on the left, press # to repeat, and press \* to return". After pressing the specified button, the voice prompt "Operation successful"

### 4.6.2 Demo Mode Settings

 **0**

Press and hold the 0 button for 3 seconds to enter the experience mode settings, and press the **1** key to enable it, press the **2** key to disable it, until it prompts: the operation is successful. Demo mode is disabled by default.

Note: The demo mode option will only appear on the system after no unlocking credentials are added to the door lock or the factory settings are restored.

### 4.6.3 Anti-tampering Alarm Settings

 **0**

In the case of only the default administrator password, press and hold the 0 button to enter the administrator password to enter the next level menu, and press 8888 continuously to turn on the anti-tampering alarm, and press 9999 continuously to turn off the anti-tampering alarm.

## 5 Use The Lock

### 5.1 Outdoor Locking/Unlocking

#### Password Unlocking

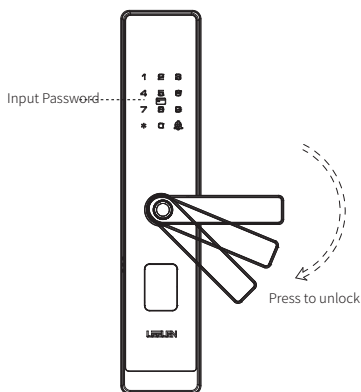

Outdoor | Front Panel

Touch the keyboard touch area to wake up the keyboard, enter the 6-digit password and press the “#” key to confirm. If the password is correct, you can hear the door opening prompt tone. Please press the handle to open the door within 3 seconds (default).

#### Fingerprint Unlocking

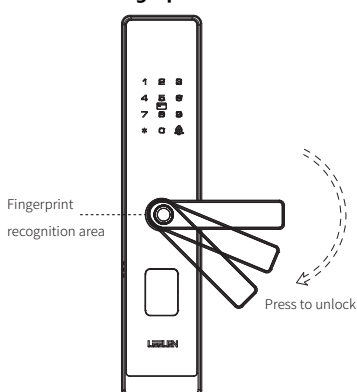

Outdoor | Front Panel

Place the registered finger in the center of the fingerprint collector. When you hear the prompt tone, press the handle to open the door within 3 seconds by default.

#### Card Unlocking

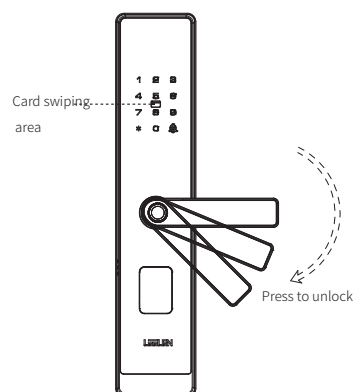

Outdoor | Front Panel

Align the smart card to the card recognition area, and press the handle to open the door within 3 seconds after hearing the door opening prompt tone.

#### Key Unlocking

Press the top of the key cover, rotate the raised part, insert the key into the key hole and turn it to unlock until the lock tongue is fully retracted, and push it lightly to open the door.



Outdoor | Front Panel

▲ Do not leave the mechanical key in the house, choose a safe and accessible place to keep it for use in extreme situations.

#### Outdoor lock

Simply lift the handle from outside the door to lock it.

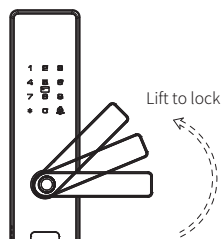

Outdoor | Front Panel

### Indoor locking/unlocking

#### Lock

Lift the handle to lock

#### Anti-lock

After the anti-lock knob is turned to the "1" position, press the handle down to unlock it.

#### Unlock

Press the handle down to unlock

#### Unlock anti-lock

After the anti-lock knob is turned to the "I" position, the anti-lock can be unlocked.

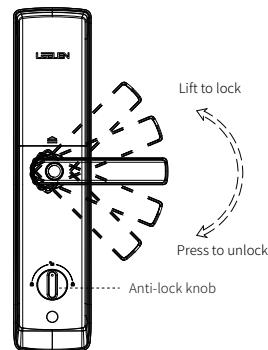

Indoor | Black Panel



## 6 Other Functions

### 6.1 Restore Factory Settings

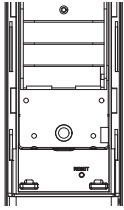

Indoor | Rear Panel

Open the battery cover, click the RESET button, press the RESET button for 5 seconds with a pin, and press the button within 10 seconds according to the voice prompt. Finally, the voice prompt will be heard, and the door lock system will be initialized successfully.

### 6.2 Battery Replacement

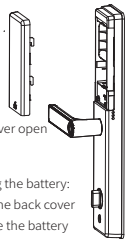

Battery cover open

Replacing the battery:  
1. Open the back cover  
2. Replace the battery  
3. Close the back cover

Indoor | Rear Panel

When the system voice prompts "Battery is low, please replace the upper/lower four batteries", you need to replace the corresponding batteries in time.

### 6.3 Emergency Power Supply Method

When the battery voltage is low and the door cannot be opened from the outside, you can open the key cover, connect a 5V or higher power bank to the emergency power supply port (Type-C), charge for more than five minutes, and then unlock the door with a fingerprint, password or card.

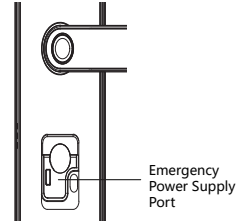

Outdoor | Front Panel

### 6.4 System Restart

If you need to restart the system, you can use a 5V or higher power bank as an emergency power source, power on the door lock through the Type-C port, and then restart it.

## 7 Basic Parameters

Front panel (L\*W\*H): 378\*79\*77.75mm

Rear panel (L\*W\*H): 378\*79\*76.1 mm

Shell Material: Aluminum alloy + glass cover

Lock body type: 6068 standard lock body/Overlord lock body

Input power: 4 AA batteries

Emergency power supply interface: Type-C 5V power supply port

Working temperature: -25°C ~ +70°C

Working humidity: ≤95%RH, non-condensing

Protection class: IP52

User capacity:

100 fingerprints (99+management 1)

100 passwords (99+management 1)

1 one-time password

100 cards

Environmental adaptability level: Level II

Product safety level: Class B

Lock cylinder security level: C level

## 8 Restricted Substances

Part Name	Toxic and hazardous substances or elements					
	Pb	Hg	Cd	Cr6+	PBB	PBDE
Metal Parts	O	O	O	O	O	O
Plastic Parts	O	O	O	O	O	O
Board Assembly*	X	O	O	O	O	O
Power Cord/Connection Cord	X	O	O	O	O	O
Lithium Battery	X	O	O	O	O	O

This form is prepared according to the provisions of SJ/T 11364:  
O: Indicates that the content of the hazardous substance in all homogeneous materials of the part is below the limit requirement in GB/T 26572  
X: Indicates that the content of the hazardous substance in at least one homogeneous material of the part exceeds the limit requirement specified in GB/T 26572  
\*: Circuit board assembly includes printed circuit board and its components, such as resistors, capacitors, integrated circuits, etc.